

Single-Phase, Integrated Heatsink Type SSR [Top-Bottom Terminal]

SRH1 Series

[Top-Bottom Terminal]

Single-Phase, Integrated Heatsink Type SSR [Top-Bottom Terminal]

■ Features

- High heat dissipation efficiency with ceramic PCB and integrated heatsink
- Input Indicator (green LED)
- DIN rail mount or panel mount installation
- [Voltage input type]
Zero cross turn-on, random turn-on models available
- [Current input type]
Phase control and cycle control possible
 - Phase control (power equality division/phase equality division)
 - Cycle control (fixed cycle/variable cycle)

⚠ Please read "Safety considerations" in operation manual before using.



Line-up

[Voltage input type]



[Current input type]



■ Ordering Information

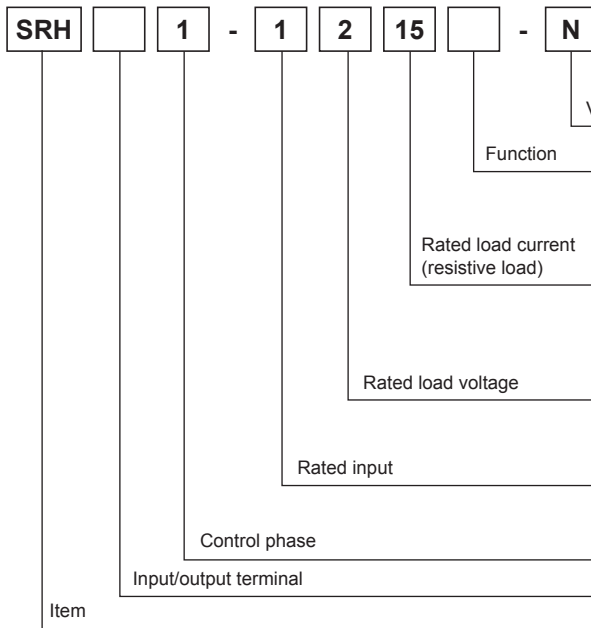

	Voltage input type	Current input type
Version	N: Renewal	
Function	No Mark: Zero cross turn-on	—
	R: Random turn-on	—
Rated load current (resistive load)	10: 10A	—
	15: 15A	—
	20: 20A	20A
	30: 30A	30A
	40: 40A	—
	60: 60A	60A
Rated load voltage	2: 24-240VAC	100-240VAC
	4: 48-480VAC	200-480VAC
Rated input	1: 4-30VDC	—
	2: 24VAC	—
	4: 90-240VAC	—
Control phase	A: —	4-20mA
Input/output terminal	1: Single-phase	—
	No Mark: Top-Bottom terminal	—
Item	SRH: Solid State Relay (integrated heatsink type)	—

※ This ordering information is only for reference. For ordering a specific model, check the ordering information of the model.

※ For more information about models, refer to the [B-16 page for the voltage input type] [B-22 page for the current input type]

- (A) Photoelectric Sensors
- (B) Fiber Optic Sensors
- (C) Door/Area Sensors
- (D) Proximity Sensors
- (E) Pressure Sensors
- (F) Rotary Encoders
- (G) Connectors/ Connector Cables/ Sensor Distribution Boxes/Sockets
- (H) Temperature Controllers
- (I) SSRs / Power Controllers
- (J) Counters
- (K) Timers
- (L) Panel Meters
- (M) Tacho / Speed / Pulse Meters
- (N) Display Units
- (O) Sensor Controllers
- (P) Switching Mode Power Supplies
- (Q) Stepper Motors & Drivers & Controllers
- (R) Graphic/ Logic Panels
- (S) Field Network Devices
- (T) Software

SRH1 Series

Single-Phase, Integrated Heatsink Type SSR [Voltage Input Type]

■ Model

Model	Rated input voltage	Rated load voltage	Rated input current	Function
SRH1-1210-N	4-30VDC	10A	24-240VAC	Zero cross turn-on
SRH1-2210-N	24VAC			
SRH1-4210-N	90-240VAC			
SRH1-1215-N	4-30VDC	15A		
SRH1-2215-N	24VAC			
SRH1-4215-N	90-240VAC			
SRH1-1220-N	4-30VDC	20A		
SRH1-2220-N	24VAC			
SRH1-4220-N	90-240VAC			
SRH1-1230-N	4-30VDC	30A		
SRH1-2230-N	24VAC			
SRH1-4230-N	90-240VAC			
SRH1-1240-N	4-30VDC	40A		
SRH1-2240-N	24VAC			
SRH1-4240-N	90-240VAC			
SRH1-1260-N	4-30VDC	60A		
SRH1-2260-N	24VAC			
SRH1-4260-N	90-240VAC			
SRH1-1410-N	4-30VDC	10A	48-480VAC	Zero cross turn-on
SRH1-1410R-N	4-30VDC			Random turn-on
SRH1-2410-N	24VAC			Zero cross turn-on
SRH1-1415-N	4-30VDC	15A		Zero cross turn-on
SRH1-1415R-N				Random turn-on
SRH1-2415-N				24VAC
SRH1-1420-N	4-30VDC	20A		Zero cross turn-on
SRH1-1420R-N				Random turn-on
SRH1-2420-N				24VAC
SRH1-1430-N	4-30VDC	30A		Zero cross turn-on
SRH1-1430R-N				Random turn-on
SRH1-2430-N				24VAC
SRH1-1440-N	4-30VDC	40A	Zero cross turn-on	
SRH1-1440R-N			Random turn-on	
SRH1-2440-N			24VAC	Zero cross turn-on
SRH1-1460-N	4-30VDC	60A	Zero cross turn-on	
SRH1-1460R-N			Random turn-on	
SRH1-2460-N			24VAC	Zero cross turn-on

■ Specifications

◎ Input

Rated input voltage range	4-30VDC≡	24VACrms~ (50/60Hz)	90-240VACrms~ (50/60Hz)
Allowable input voltage range	4-32VDC≡	19-30VACrms~ (50/60Hz)	85-264VACrms~ (50/60Hz)
Max. input current	18mA	15mA _{rms} (24VACrms~)	18mA _{rms} (240VACrms~)
Pick-up voltage	Min. 4VDC≡	Min. 19VACrms~	Min. 85VACrms~
Drop-out voltage	Max. 1VDC≡	Max. 4VACrms~	Max. 10VACrms~
Turn-on time	Zero cross turn-on	Max. 0.5 cycle of load source + 1ms	Max. 2 cycle of load source + 1ms
	Random turn-on	Max. 1ms	—
Turn-off time		Max. 0.5 cycle of load source + 1ms	Max. 2 cycle of load source + 1ms



Single-Phase, Integrated Heatsink Type SSR [Voltage Input Type]

Output

Rated load voltage range	24-240VACrms ~ (50/60Hz)						
Allowable load voltage range	24-264VACrms ~ (50/60Hz)						
Rated load current	Resistive load (AC-51) ^{※1}	10Arms	15Arms	20Arms	30Arms	40Arms	60Arms
Min. load current		0.15Arms	0.15Arms	0.2Arms	0.5Arms	0.5Arms	0.5Arms
Max. 1 cycle surge current (60Hz)		160A	160A	250A	400A	500A	1000A
Max. non-repetitive surge current (I ² t, t=8.3ms)		130A ² s	130A ² s	300A ² s	910A ² s	1000A ² s	4000A ² s
Peak voltage (non-repetitive)		600V					
Leakage current (Ta=25°C)		Max. 10mArms (240VAC~/60Hz)					
Output on voltage drop [Vpk] (max. load current)		Max. 1.6V					
Static off state dv/dt		500V/μs					
Rated load voltage range	48-480VACrms ~ (50/60Hz)						
Allowable load voltage range	48-528VACrms ~ (50/60Hz)						
Rated load current	Resistive load (AC-51) ^{※1}	10Arms	15Arms	20Arms	30Arms	40Arms	60Arms
Min. load current		0.5Arms	0.5Arms	0.5Arms	0.5Arms	0.5Arms	0.5Arms
Max. 1 cycle surge current (60Hz)		300A	300A	300A	500A	500A	1000A
Max. non-repetitive surge current (I ² t, t=8.3ms)		350A ² s	350A ² s	350A ² s	1000A ² s	1000A ² s	4000A ² s
Peak voltage (non-repetitive)		1200V (zero cross turn-on), 1000V (random turn-on)					
Leakage current (Ta=25°C)		Max. 10mArms (480VAC~/60Hz)					
Output on voltage drop [Vpk] (max. load current)		Max. 1.6V					
Static off state dv/dt		500V/μs					

※1: AC-51 is utilization category at IEC60947-4-3.

General specifications

Dielectric strength (Vrms)	2500VAC 50/60Hz 1 min (input-output, input/output-case)	
Insulation resistance	Over 100MΩ (at 500VDC megger) (input-output, input/output-case)	
Indicator	Input indicator: green LED	
Vibration	Mechanical	0.75mm amplitude at frequency of 10 to 55Hz (for 1 min) in each X, Y, Z direction for 1 hour
	Malfunction	0.5mm amplitude at frequency of 10 to 55Hz (for 1 min) in each X, Y, Z direction for 10 min
Shock	Mechanical	300m/s ² (approx. 30G) in each X, Y, Z direction for 3 times
	Malfunction	100m/s ² (approx. 30G) in each X, Y, Z direction for 3 times
Environment	Ambient temp.	-30 to 80°C (in case of the rated input voltage 90-240VAC~: -20 to 70°C), storage: -30 to 100°C (The rated load current capacity is different depending on ambient temperature. Refer to '■ SSR Derating Curve'.)
	Ambient humi.	45 to 85%RH, storage: 45 to 85%RH
Input terminal connection	Min. 1×0.5mm ² (1×AWG20), max. 1×1.5mm ² (1×AWG16) or 2×1.5mm ² (2×AWG16)	
Output terminal connection	<ul style="list-style-type: none"> Rated load current 10A/15A/20A : Min. 1×0.75mm² (1×AWG18), max. 1×4mm² (1×AWG12) or 2×2.5mm² (2×AWG14) Rated load current 30A/40A/60A : Min. 1×1.5mm² (1×AWG16), max. 1×16mm² (1×AWG6) or 2×6mm² (2×AWG10) ※Use wires compliant with load current capacity to connect to the terminal.	
Input terminal fixed torque	0.75 to 0.95N·m	
Output terminal fixed torque	<ul style="list-style-type: none"> Rated load current 10A/15A/20A: 1.0 to 1.35N·m Rated load current 30A/40A/60A: 1.6 to 2.2N·m 	
Approval	  	
Weight ^{※1}	<ul style="list-style-type: none"> Rated load current 10A/15A/20A: approx. 298g (approx. 225g) Rated load current 30A/40A: approx. 500g (approx. 410g) Rated load current 60A: approx. 770g (approx. 680g) 	

※1: The weight includes packaging. The weight in parenthesis is for unit only.

※Environment resistance is rated at no freezing or condensation.

※For wiring the terminal, round terminal must be used.

(A) Photoelectric Sensors

(B) Fiber Optic Sensors

(C) Door/Area Sensors

(D) Proximity Sensors

(E) Pressure Sensors

(F) Rotary Encoders

(G) Connectors/ Connector Cables/ Sensor Distribution Boxes/Sockets

(H) Temperature Controllers

(I) SSRs / Power Controllers

(J) Counters

(K) Timers

(L) Panel Meters

(M) Tacho / Speed / Pulse Meters

(N) Display Units

(O) Sensor Controllers

(P) Switching Mode Power Supplies

(Q) Stepper Motors & Drivers & Controllers

(R) Graphic/ Logic Panels

(S) Field Network Devices

(T) Software

SRH1 Series

■ Dimensions

● Rated load current 10A/15A/20A

● Rated load current 30A/40A

(unit: mm)

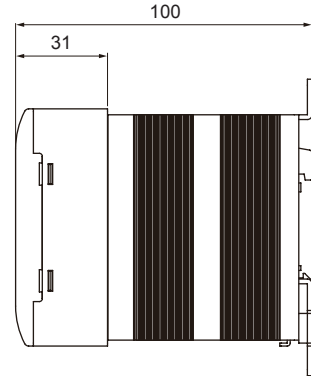
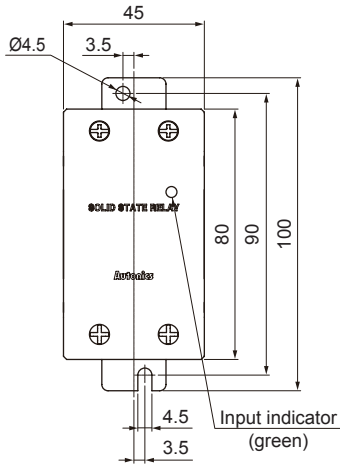
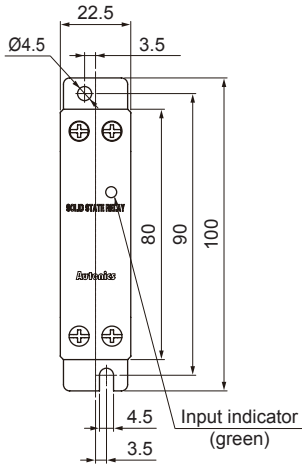

● Rated load current 60A

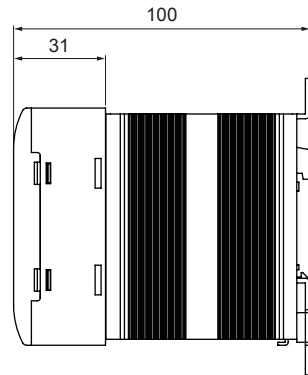
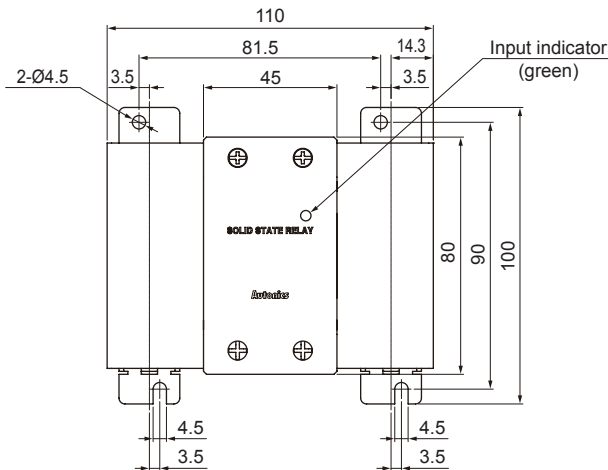

○ Panel cut-out

● Rated load current 10A/15A/20A/30A/40A

● Rated load current 60A

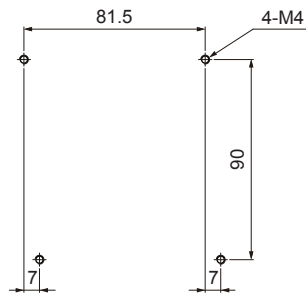
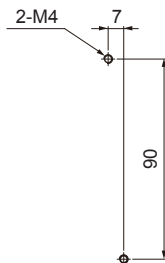

※Screw tightening torque for mounting: 1.8 to 2.5N·m

Single-Phase, Integrated Heatsink Type SSR [Voltage Input Type]

(unit: mm)

○ DIN rail mounting

● DIN rail attachment

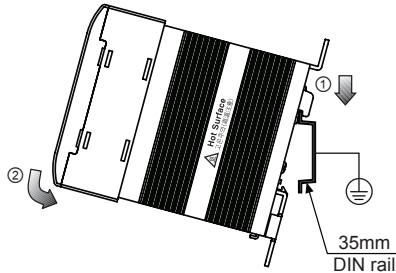

※DIN rail must be grounded.

● DIN rail detachment

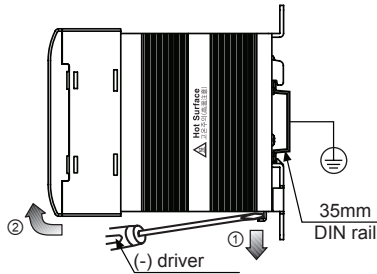

○ Spacing

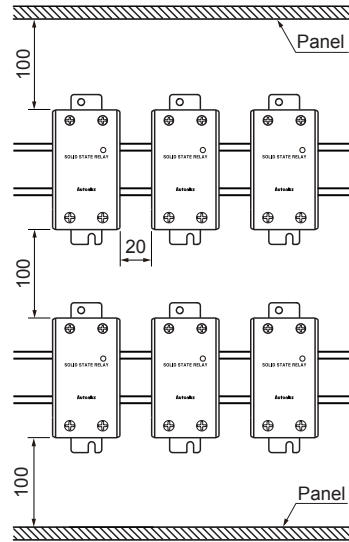

※When installing multiple SSRs, please keep space between SSRs for heat radiation. When installing SSRs horizontally (input part and output part on the same height), please supply less than 50% of the rated load current.

⚠ High temperature caution

While supplying power to the load or right after turning off the power of the load, do not touch the body and heat sink. Failure to follow this instruction may result in a burn due to the high temperature.

■ Connections

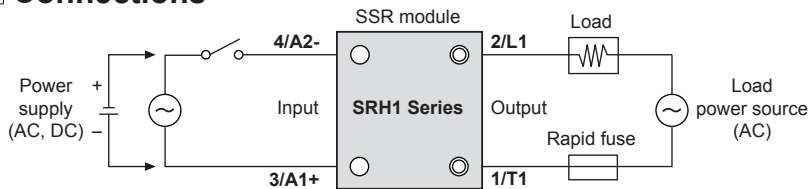

※Use terminals of size specified below.

Terminal type	Input	Output	
Rated load current	10A, 15A, 20A, 30A, 40A, 60A	10A, 15A, 20A	30A, 40A, 60A
 <Round>	a	Min. 3.5mm	Min. 4.0mm
	b	Max. 7.0mm	Max. 9.0mm

(A)	Photoelectric Sensors
(B)	Fiber Optic Sensors
(C)	Door/Area Sensors
(D)	Proximity Sensors
(E)	Pressure Sensors
(F)	Rotary Encoders
(G)	Connectors/ Connector Cables/ Sensor Distribution Boxes/Sockets
(H)	Temperature Controllers
(I)	SSRs / Power Controllers
(J)	Counters
(K)	Timers
(L)	Panel Meters
(M)	Tacho / Speed / Pulse Meters
(N)	Display Units
(O)	Sensor Controllers
(P)	Switching Mode Power Supplies
(Q)	Stepper Motors & Drivers & Controllers
(R)	Graphic/ Logic Panels
(S)	Field Network Devices
(T)	Software

SRH1 Series

■ SSR Derating Curve

◎ SRH1-1210/2210/4210-N

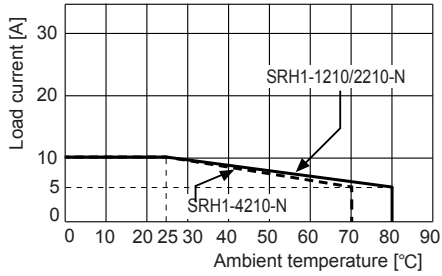

◎ SRH1-1410/1410R/2410-N

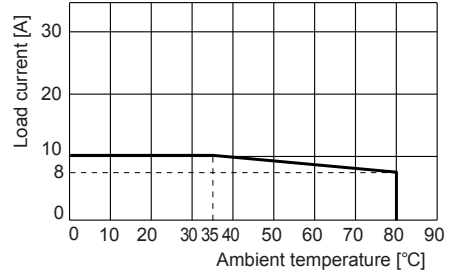

◎ SRH1-1215/2215/4215-N

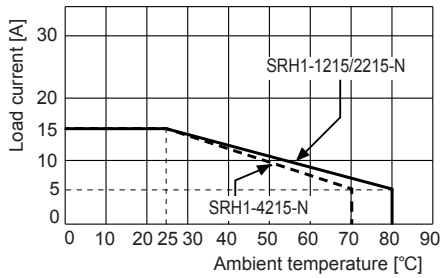

◎ SRH1-1415/1415R/2415-N

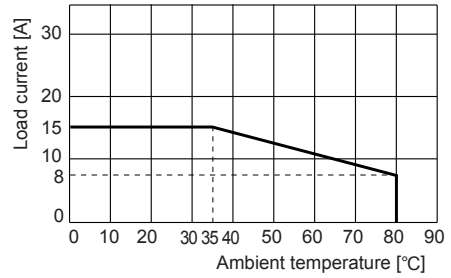

◎ SRH1-1220/2220/4220-N

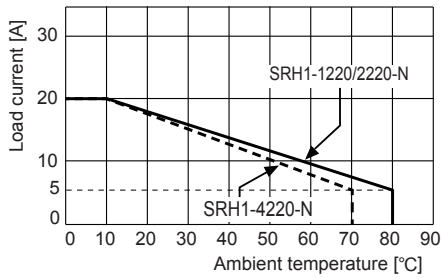

◎ SRH1-1420/1420R/2420-N

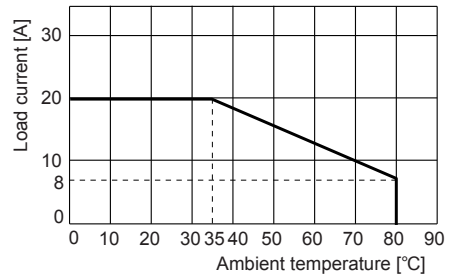

◎ SRH1-1230/2230/4230-N

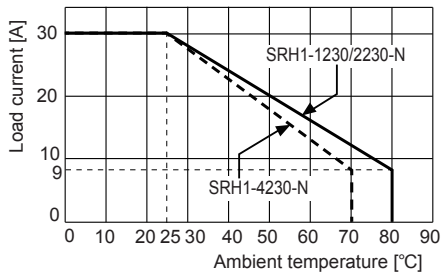

◎ SRH1-1430/1430R/2430-N

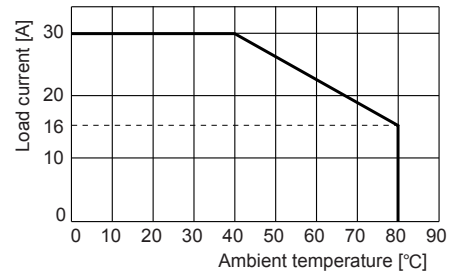

Single-Phase, Integrated Heatsink Type SSR [Voltage Input Type]

◎ SRH1-1240/2240/4240-N

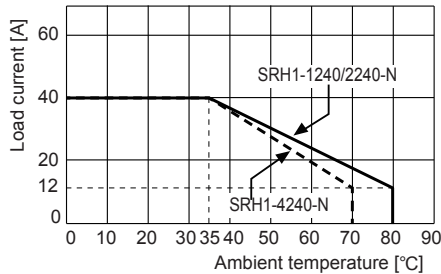

◎ SRH1-1440/1440R/2440-N

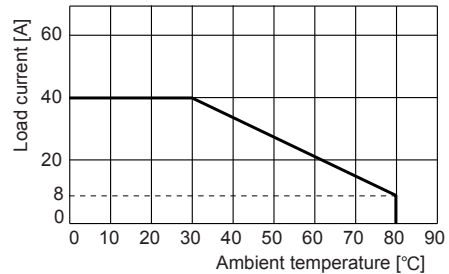

◎ SRH1-1260/1460/1460R-N SRH1-2260/2460/4260-N

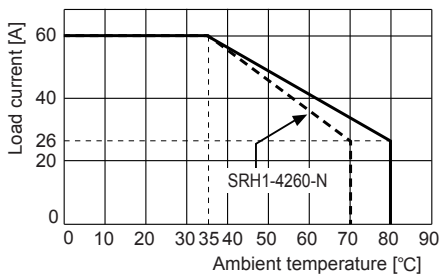

△ Since effectiveness of the heat radiation is decreased when multiple SSRs are installed closely, please supply less than 50% of the rated load current.

✕ Above SSR derating curves obtained approval from the UL certification authority.

■ Proper Usage

⚠ Cautions during use

- Follow instructions in 'Cautions during Use'. Otherwise, it may cause unexpected accidents.
- 4-30VDC, 24VAC signal input should be insulated and limited voltage/current or Class 2, SELV power supply device.
- Install the unit in the well ventilated place.
- Ground to the heat sink, panel, or DIN rail. Failure to follow this instruction may result in electric shock.
- Ground to the panel. Failure to follow this instruction may result in electric shock.
- While supplying power to the load or right after turning off the power of the load, do not touch the body and heat sink. Failure to follow this instruction may result in a burn due to the high temperature.
- In order to protect the product from the short-circuit current of the load, use rapid fuse of which I^2t is under the 1/2 of SSR I^2t . When short-circuited, replace the fuse to those of same specification with the used rapid fuse.
- Install dummy resistance in parallel with the load, to keep the sum of current flowing in the load and dummy resistance being over SSR minimum load current.
- When using random turn-on model for phase control, install noise filter between the load and the power of the load.
- Do not use near the equipment which generates strong magnetic force or high frequency noise.
- This unit may be used in the following environments.
 - Indoors (in the environment condition rated in 'Specifications')
 - Altitude max. 2,000m
 - Pollution degree 2
 - Installation category III

(A) Photoelectric Sensors

(B) Fiber Optic Sensors

(C) Door/Area Sensors

(D) Proximity Sensors

(E) Pressure Sensors

(F) Rotary Encoders

(G) Connectors/ Connector Cables/ Sensor Distribution Boxes/Sockets

(H) Temperature Controllers

(I) SSRs / Power Controllers

(J) Counters

(K) Timers

(L) Panel Meters

(M) Tacho / Speed / Pulse Meters

(N) Display Units

(O) Sensor Controllers

(P) Switching Mode Power Supplies

(Q) Stepper Motors & Drivers & Controllers

(R) Graphic/ Logic Panels

(S) Field Network Devices

(T) Software

SRH1 Series

Single-Phase, Integrated Heatsink Type SSR [Current Input Type]

■ Model

Model	Rated input current	Rated load current	Rated load voltage	Model	Rated input current	Rated load current	Rated load voltage
SRH1-A220-N	4-20mA	20A	100-240VAC	SRH1-A420-N	4-20mA	20A	200-480VAC
SRH1-A230-N		30A		SRH1-A430-N		30A	
SRH1-A260-N		60A		SRH1-A460-N		60A	

■ Specifications

○ Input

Rated input current	4-20mA
Max. allowable input current	50mA
Pick-up current	Min. 4.2mA
Static off current	Max. 4.0mA
Power factor	Min. 0.9 (max. 25° of difference between voltage phase and current phase)
Start-up time	60Hz: 200ms, 50Hz: 250ms
Operation time	60Hz: 16.6ms, 50Hz: 20ms
Operation mode ^{※1}	Phase control (phase equality division type, power equality division type) Cycle control (fixed cycle, variable cycle)

※1: You can change operation mode by jumper pin. Default is Phase control (Power equality division type).

○ Output

Rated load voltage range	100-240VACrms ~ (50/60Hz)			200-480VACrms ~ (50/60Hz)		
Allowable load voltage range	90-264VACrms ~ (50/60Hz)			200-528VACrms ~ (50/60Hz)		
Rated load current	20Arms	30Arms	60Arms	20Arms	30Arms	60Arms
Resistive load (AC-51) ^{※1}						
Min. load current	0.5Arms			0.5Arms		
Max. 1 cycle surge current (60Hz)	300A	500A	1000A	300A	500A	1000A
Max. non-repetitive surge current (I ² t, t=8.3ms)	350A ² s	1000A ² s	4000A ² s	350A ² s	1000A ² s	4000A ² s
Peak voltage (non-repetitive)	600V			1000V		
Leakage current (Ta=25°C)	Max. 10mArms (240VAC~/60Hz)			Max. 10mArms (480VAC~/60Hz)		
Output on voltage drop[Vpk] (Max. load current)	Max. 1.6V					
Static off-state dv/dt	500V/μs					

※1: AC-51 are utilization category at IEC60947-4-3.

○ General specifications

Phase control (phase equality division type)	5 to 99%	
Phase control (power equality division type)	10 to 99%	
Frequency reading function	Yes	
Dielectric strength (Vrms)	4000VAC 50/60Hz for 1 min (input-output, input/output-case)	
Insulation resistance	Over 100MΩ (at 500VDC megger)	
Indicator	Input indicator: green LED	
Vibration	0.75mm amplitude at frequency of 10 to 55Hz (for 1 min) in each X, Y, Z direction for 1 hour	
Environment	Ambient temp.	-20 to 70°C, storage: -20 to 100°C (The rated load current capacity is different depending on ambient temperature. Refer to '■ SSR Derating Curve'.)
	Ambient humi.	45 to 85%RH, storage: 45 to 85%RH
Input terminal connection	Min. 1×0.5mm ² (1×AWG20), max. 1×16mm ² (1×AWG6) or 2×1.5mm ² (2×AWG16)	
Output terminal connection	Min. 1×1.5mm ² (1×AWG16), max. 1×16mm ² (1×AWG6) or 2×6mm ² (2×AWG10) ※Use wires compliant with load current capacity to connect to the terminal.	
Input terminal fixed torque	0.75 to 0.95N·m	
Output terminal fixed torque	1.6 to 2.2N·m	
Approval	CE  us	
Unit weight	• Rated load current 20A/30A: Approx. 410g • Rated load current 60A: Approx. 680g	

※Environment resistance is rated at no freezing or condensation.

※For wiring the terminal, round terminal must be used.

Single-Phase, Integrated Heatsink Type SSR [Current Input Type]

■ Dimensions

(unit: mm)

● Rated load current 20A/30A

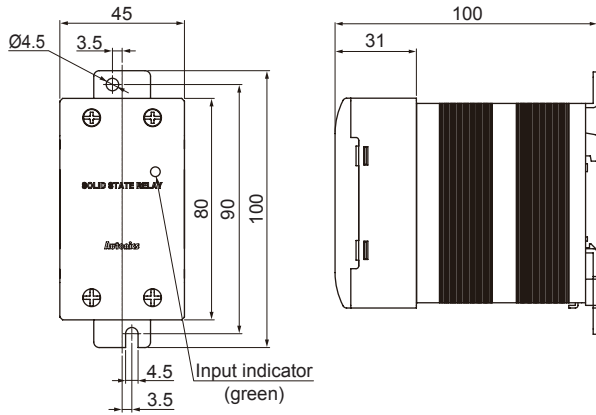

○ Panel cut-out

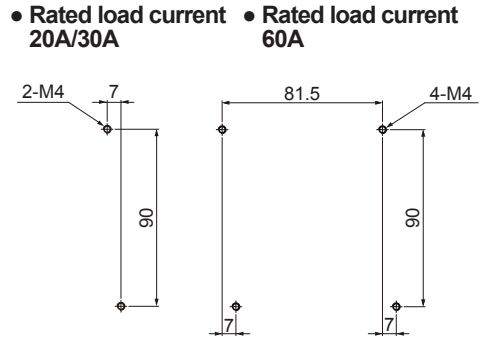

※Screw tightening torque for mounting: 1.8 to 2.5N·m

● Rated load current 60A

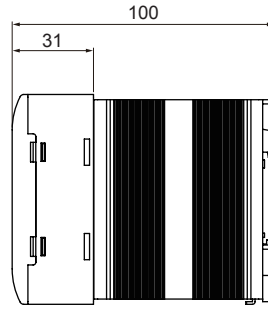
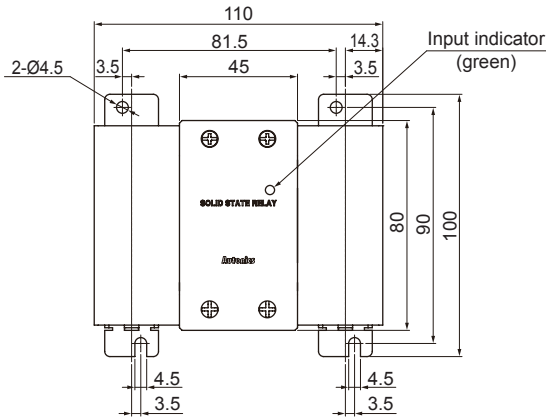

○ DIN rail mounting

● DIN rail attachment

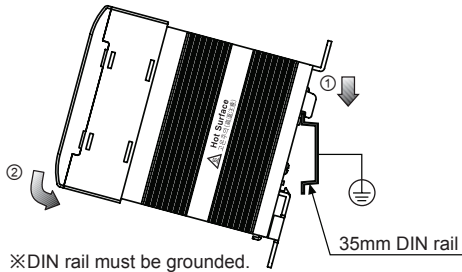

● DIN rail detachment

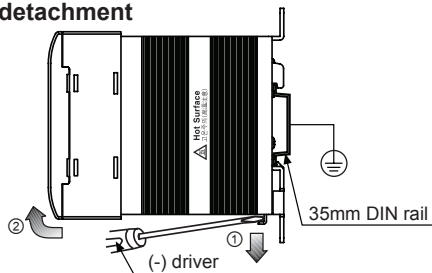

○ Spacing

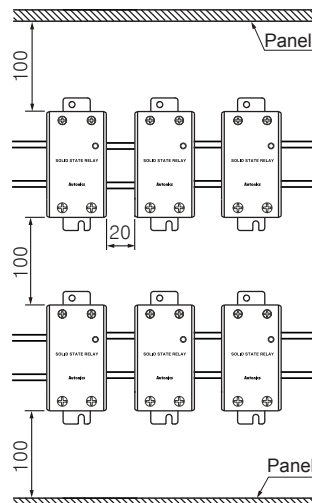

※When installing multiple SSRs, please keep space between SSRs for heat radiation. When installing SSRs horizontally (input part and output part on the same height), please supply less than 50% of the rated load current.

High temperature caution
While supplying power to the load or right after turning off the power of the load, do not touch the body and heat sink. Failure to follow this instruction may result in a burn due to the high temperature.

(A)	Photoelectric Sensors
(B)	Fiber Optic Sensors
(C)	Door/Area Sensors
(D)	Proximity Sensors
(E)	Pressure Sensors
(F)	Rotary Encoders
(G)	Connectors/ Connector Cables/ Sensor Distribution Boxes/Sockets
(H)	Temperature Controllers
(I)	SSRs / Power Controllers
(J)	Counters
(K)	Timers
(L)	Panel Meters
(M)	Tacho / Speed / Pulse Meters
(N)	Display Units
(O)	Sensor Controllers
(P)	Switching Mode Power Supplies
(Q)	Stepper Motors & Drivers & Controllers
(R)	Graphic/ Logic Panels
(S)	Field Network Devices
(T)	Software

SRH1 Series

■ Connections

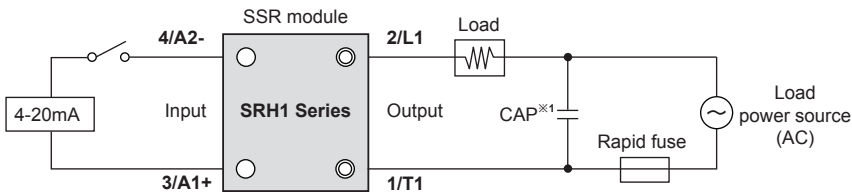

※1: When connecting noise filter and capacitor, it is appropriate for EMC.

CAP: Rated load voltage 100-240VAC → 1uF/250VAC
 Rated load voltage 200-480VAC → 0.47uF/500VAC

※Use terminals of size specified below.

Terminal type	Input	Output
 <Round>	a	Min. 3.5mm
	b	Max. 7.0mm
		Min. 5.0mm
		Max. 12.0mm

■ SSR Derating Curve

○ SRH1-A220/A420-N

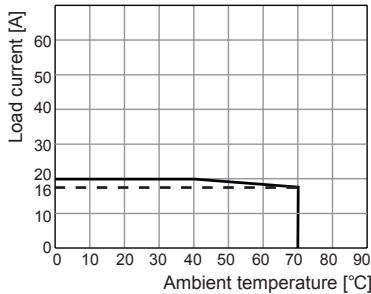

○ SRH1-A230/A430-N

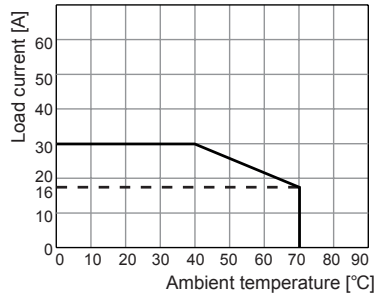

○ SRH1-A260/A460-N

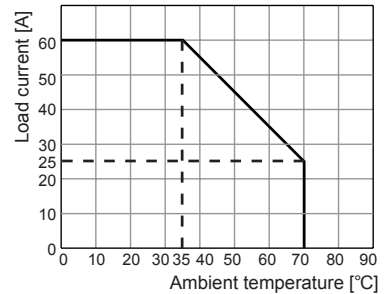

⚠ Since effectiveness of the heat radiation is decreased when multiple SSRs are installed closely, please supply less than 50% of the rated load current.

※Above SSR derating curves obtained approval from the UL certification authority.

■ Operation Setting

● Detach front cover

Press front cover connection 4 parts at right and left side with (-) driver, and front cover is detached.

※Before detaching front cover, you must cut off load current and input.

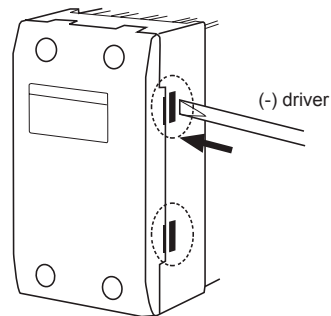

● Jumper pin setting

Operation mode is decided by jumper position.
 After changing operation mode, re-supply input signal.

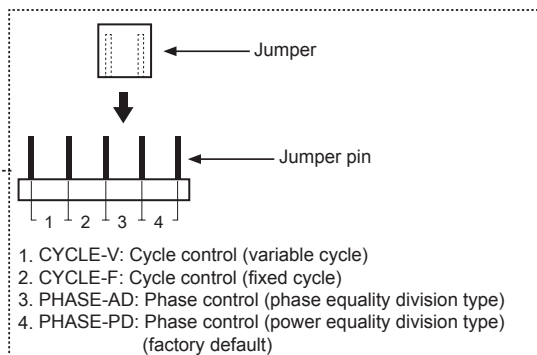
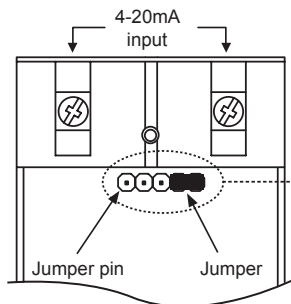

Single-Phase, Integrated Heatsink Type SSR [Current Input Type]

■ Operation Mode

○ Phase control

● Output waveform of phase control

- When control input signal is 25%
- When control input signal is 50%
- When control input signal is 75%

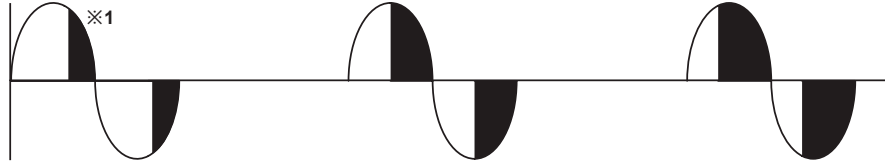

※1: The black parts of output waveform are output on the load.

● Power equality division type

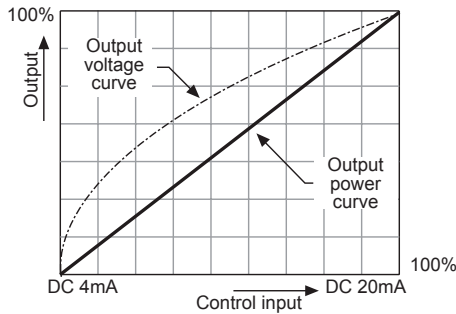

Controls output power which is proportional to control input (4-20mA) level.

● Phase equality division type

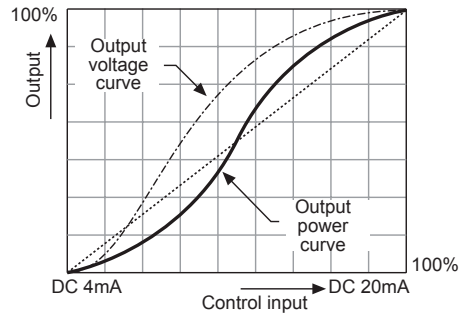

Controls phase angle which is proportional to control input (4-20mA) level.

○ Cycle control

● Fixed cycle

Controls continuously the number of full cycle which is supplied to load every 1 sec by being proportional to control input (4-20mA).

- When control input signal is 0%
- When control input signal is 50%
- When control input signal is 100%

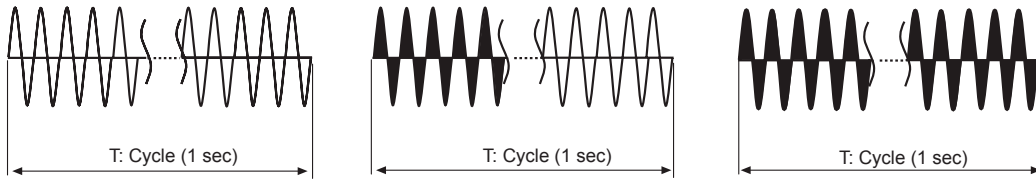

● Variable cycle

Controls fast and accurately the subject with optimized the number of AC voltage cycle which is supplied to load by being proportional to control input (4-20mA).

- When control input signal is 10%
- When control input signal is 50%
- When control input signal is 90%

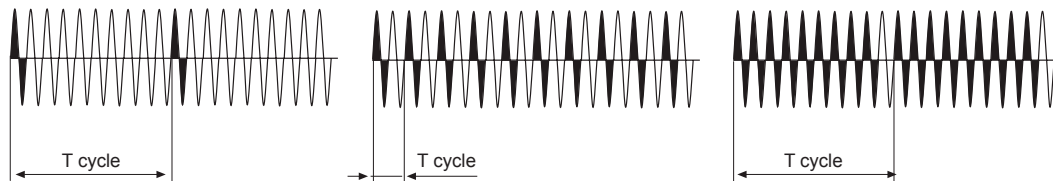

(A)	Photoelectric Sensors
(B)	Fiber Optic Sensors
(C)	Door/Area Sensors
(D)	Proximity Sensors
(E)	Pressure Sensors
(F)	Rotary Encoders
(G)	Connectors/ Connector Cables/ Sensor Distribution Boxes/Sockets
(H)	Temperature Controllers
(I)	SSRs / Power Controllers
(J)	Counters
(K)	Timers
(L)	Panel Meters
(M)	Tacho / Speed / Pulse Meters
(N)	Display Units
(O)	Sensor Controllers
(P)	Switching Mode Power Supplies
(Q)	Stepper Motors & Drivers & Controllers
(R)	Graphic/ Logic Panels
(S)	Field Network Devices
(T)	Software

■ Proper Usage

⚠ Cautions during use

1. Follow instructions in 'Cautions during Use'. Otherwise, it may cause unexpected accidents.
2. Install the unit in the well ventilated place.
3. Ground to the heat sink, panel, or DIN rail. Failure to follow this instruction may result in electric shock.
4. While supplying power to the load or right after turning off the power of the load, do not touch the body and heat sink. Failure to follow this instruction may result in a burn due to the high temperature.
5. In order to protect the product from the short-circuit current of the load, use rapid fuse of which I^2t is under the 1/2 of SSR I^2t . When short-circuited, replace the fuse to those of same specification with the used rapid fuse.
6. Install dummy resistance in parallel with the load, to keep the sum of current flowing in the load and dummy resistance being over SSR minimum load current.
7. Do not use near the equipment which generates strong magnetic force or high frequency noise.
8. This unit may be used in the following environments.
 - ① Indoors (in the environment condition rated in 'Specifications')
 - ② Altitude max. 2,000m
 - ③ Pollution degree 2
 - ④ Installation category III